



VIVA ace

Quick Operation Guide

Quick Operation Guide is an excerpt from the Operation Manual.
Please be sure to read the Operation Manual thoroughly.



VIVA ace Quick Operation Guide

Contents

1. Installing the Holder Bar and Arm	2	12. Ultrasonic Scaler.....	14
2. Connecting the Motor, the Scaler, and the Syringe ...	3	13. Light Probe	15
3. Installing the Vacuum	4	14. Vacuum	16
4. Installing the Water Bottle	5	15. Sync Mode (Synchro Mode)	16
5. Connecting the Foot Control	6	16. 3way Syringe.....	17
6. Connecting the AC Power Cord.....	6	17. When the Water bottle is empty or the Vacuum bottle is filled with liquid during use	17
7. Check before treatment	7	18. Storage Procedure	18
8. Control Panel	8	19. Troubleshooting	22
9. Liquid Crystal Display of the Control Panel	10		
10. Motor	12		
11. Motor <Endodontic treatment>	13		

1. Installing the Holder Bar and Arm

- 1** Pull down the Holder Bar Lock and stretch the Holder Bar upward. The position can be set at four points.

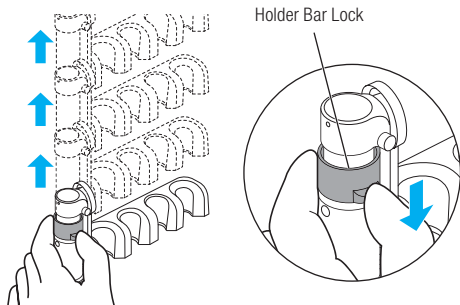

- 2** Press the Holder Arm Lock and turn the holder forward. The position can be set at four points.

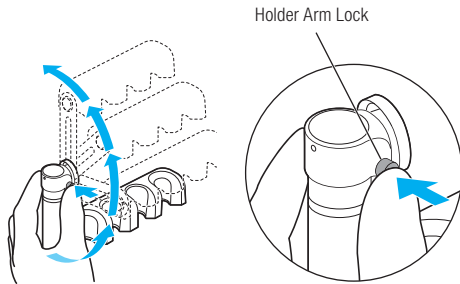

2. Connecting the Motor, the Scaler, and the Syringe

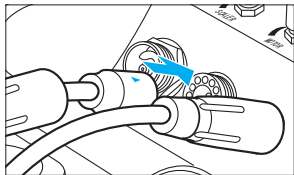

Connect each connector with
▲ mark upside.

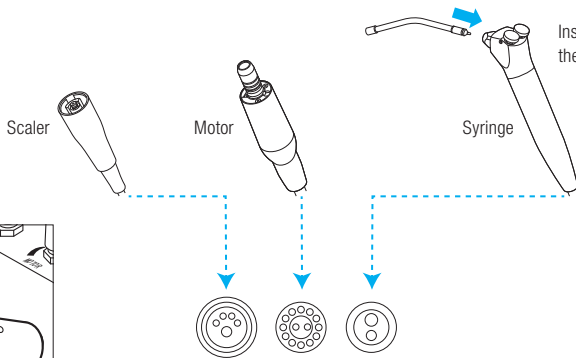

Insert the syringe nozzle into
the syringe.

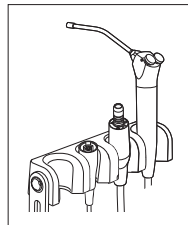

Place the Motor, the Scaler and
the Syringe on the Holder.

3. Installing the Vacuum

- 1 After checking that the Vacuum Bottle lid is tightly closed, place the Vacuum Bottle in the Control Unit. Insert the Vacuum Junction Hose and the Vacuum Hose to the Vacuum Bottle Lid until they meet the end.

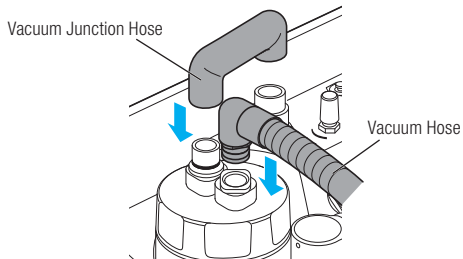

- 2 Insert the Vacuum Valve to the Vacuum Hose, then insert the Suction Tube to the Vacuum Valve.

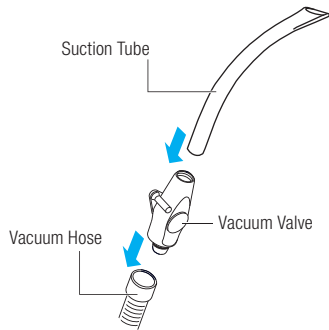

4. Installing the Water Bottle

- 1 Fill with drinking water until it reaches below the maximum line (350 ml). Then tightly close the Water Bottle lid.

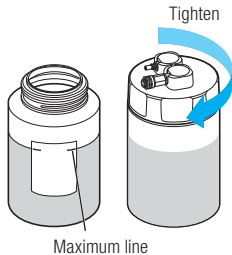

- 2 Insert the Water Plug to the lid until hearing a clicking sound.

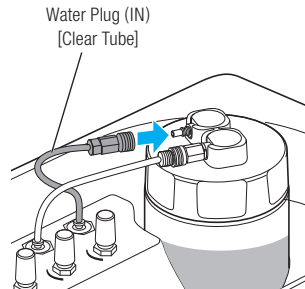
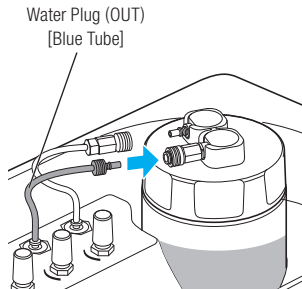

5. Connecting the Foot Control

Insert the FC-76S Foot Control Plug (Black) into the Connector on the right.
Insert the FC-70S Foot Control Plug (White) into the Connector on the left.
Insert each plug until it meets the end.

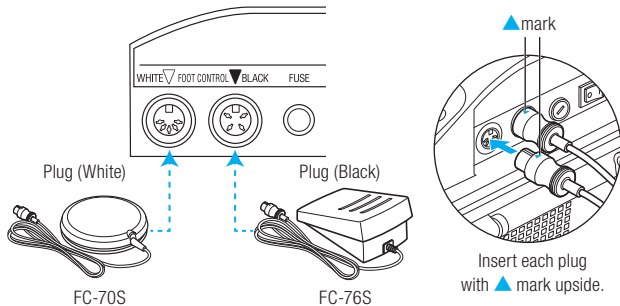

6. Connecting the AC Power Cord

After turning the Power Switch OFF (to 0 side), insert the AC Power Cord into the inlet until it meets the end. Then insert it to the commercial power outlet.

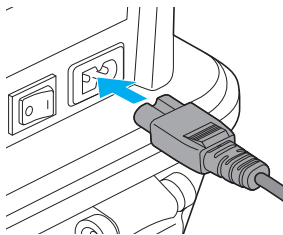

7. Check before treatment

Perform the following checks before using the product on a patient to confirm that there are no abnormalities. If abnormal vibration, noise, or overheating is detected when using or checking, stop using the product and contact your Authorized NSK Dealer.

- There is no abnormal deformation or damage in the appearance.
- Drinking water is supplied into the Water Bottle.
- All the accessories are properly connected.
- Turn the Power Switch ON (I side), and confirm that the product is in the state of stand-by as defined below.
 - The compressor is activated and stops after a few seconds.
 - The liquid crystal display of the control panel lights and notification sound rings.
- Start the Vacuum and confirm that it vacuums.
- Activate the Syringe for about 5 seconds by pressing both the air button and the water button.
- Activate the motor for about 10 seconds while applying water. Also, confirm the points below.
 - Check if there is any abnormal vibration, noise or overheating.
 - Check that the handpiece supplies water properly.
 - Check that the light on the motor is on.
- Activate the scaler for about 10 seconds while applying water. Also, confirm the points below.
 - Check that the tip is vibrating properly.
 - Check if there is any abnormal looseness, vibration, noise, or overheating with the tip.
 - Check that the tip supplies water properly.
 - Check that the light on the handpiece is on.

8. Control Panel



- ① Selecting the suitable mode and the gear ratio (1:1,1:5) for general cutting and tooth surface cleaning.
- ② Selecting the suitable mode for root canal treatment.
- ③ Selecting Light Probe Mode.
- ④ Selecting Ultrasonic Scaler.
At the same time, selecting the Treatment Mode (P, E, G).
(P : PERIO Mode, E : ENDO Mode, G : GENERAL Mode)
- ⑤ Switching ON/OFF of Motor and Scaler Operation.
- ⑥ It stores five setting programs (speed, torque, and auto reverse setting) during ENDO Mode.
- ⑦ Setting and cancellation of auto reverse function during the ENDO Mode.
- ⑧ Selecting the direction of rotation during MOTOR, ENDO Mode.
- ⑨ Selecting ON/OFF of lighting during MOTOR and ENDO, Light Probe Mode.
- ⑩ Selecting ON/OFF of Water Pouring functions during MOTOR, ENDO, and SCALER Mode.

- ⑪ Selecting the Vacuum suction power in three levels.
Selecting Linking/Unlinking of the Vacuum with Motor and Scaler.

- ⑫ ON/OFF of the Vacuum function.

⑬

During the ENDO Mode	Torque Setting (0.3 - 3.0N·cm)
During the SCALER Mode	Power Setting (1-10)
When selecting the Light Probe Mode	Sound Volume Setting (High/Low/Silent)

⑭

During the MOTOR/ENDO Mode	Speed Setting
When selecting the Light Probe Mode	Light Quantity Setting

9. Liquid Crystal Display of the Control Panel

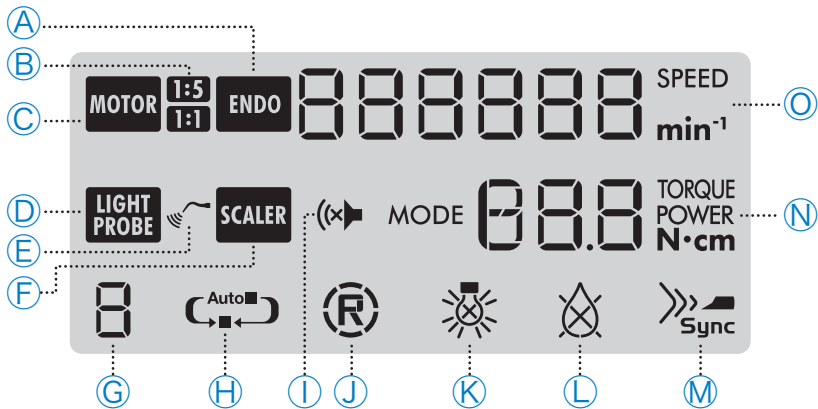

- Ⓐ Displays the ENDO Mode.
- Ⓑ Displays the gear ratio.
- Ⓒ Displays the MOTOR Mode.
- Ⓓ Displays the LIGHT PROBE Mode.
- Ⓔ Displays during the SCALER operation.
- Ⓕ Displays the SCALER Mode.
- Ⓖ Displays the memory number.
- Ⓗ Displays the current AUTO REVERSE Mode.
- Ⓘ Displays the Sound Volume Settings (High/Low/Silent).
- Ⓝ Displays the direction of rotation.
- Ⓚ Displays ON/OFF of lighting.
- Ⓛ Displays ON/OFF of Water Pouring.
- Ⓜ Displays the Vacuum suction power in three levels.
Displays Linking/Unlinking of the Vacuum with Motor and Scaler.
- Ⓝ Displays the set upper limit torque value during the ENDO Mode.
Displays the selected mode and power setting during the SCALER Mode.
- Ⓞ Displays the actual speed when the motor is running. When the motor is not running, it displays the maximum set speed.

10. Motor

1 Select the gear ratio

1:5
1:1

2 Set the speed

Gear Ratio	Speed(min ⁻¹)
1 : 5	5,000 - 200,000
1 : 1	1,000 - 40,000

7 Activate/Stop the Motor

Two ways to activate/stop the Motor are shown below :

- ① FC-76S Foot Control
- ② Manual Operation ON/OFF

Press more than 2 seconds

* Long press works only for ON

3 Select the direction of rotation

Forward Rotation (F)

Reverse Rotation (R)

4 Light ON/OFF

5 Water ON/OFF

6 Motor Water Adjustment

The water amount can be adjusted by turning the Water Adjuster.



11. Motor <Endodontic treatment>

The image shows the control panel of the NSK VIVAace motor. The panel features a central LCD screen displaying '1:1 ENDO', '100 SPEED min⁻¹', and '0.3 TORQUE N·cm'. Below the screen are several function buttons: MEMORY, AUTO REV, FWD/REV, LIGHT, SPRAY, VACUUM, and ON/OFF. To the left of the screen are four mode selection buttons: MOTOR, ENDO, LIGHT PROBE, and SCALER. To the right are two sets of up/down arrow buttons for speed and torque adjustment. A water adjuster knob is located at the bottom right.

1 Change to ENDO Mode

2 Select the program

3 Speed Setting
100 - 5,000 min⁻¹

4 Torque Setting
0.3 - 3.0 N·cm

5 Select Auto Reverse function

6 Select the direction of rotation
Forward Rotation (F)
Reverse Rotation (R)

7 Light ON/OFF

8 Water ON/OFF

9 Motor Water Adjustment
The water amount can be adjusted by turning the Water Adjuster.

10 Activate/Stop the Motor
Two ways to activate/stop the Motor are shown below :
① FC-76S Foot Control
② Manual Operation ON/OFF
Press more than 2 seconds
* Long press works only for ON

12. Ultrasonic Scaler

1 Select the treatment mode

- P : PERIO Mode
- E : ENDO Mode
- G : GENERAL Mode

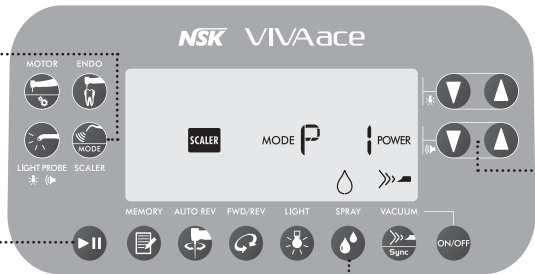

2 Power Setting

- 1 to 10
- Set it below the maximum power of the tip.

5 Activate/Stop the Scaler

Two ways to activate/stop the Scaler are shown below :

- ① FC-76S Foot Control
 - ② Manual Operation ON/OFF
- Press more than 2 seconds
* Long press works only for ON

3 Water ON/OFF

4 Scaler Water Adjustment

The water amount can be adjusted by turning the Water Adjuster.

13. Light Probe

1 Connect the Light Probe

2 Select the Light Probe Mode



3 Light Quantity Setting

Adjustments can be made in increments and is directly reflected in the light quantity of the MOTOR Mode.

4 Light ON/OFF

14. Vacuum

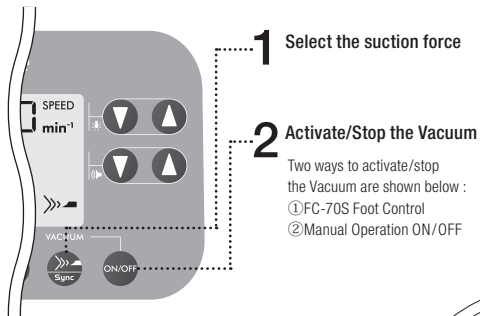

3 Vacuum ON/OFF During treatment

Suctioning stops by closing the Vacuum Valve Lever.

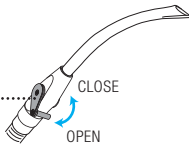

15. Sync Mode (Synchro Mode)

The Vacuum can be synchronized with the Motor and the Scaler (except during Light Probe Mode). It can be set individually at each Mode (MOTOR, ENDO, and SCALER), however the suction force value will remain the same.



Long press the VACUUM Key (More than 1 second)

	Linked
	Not Linked

16. 3way Syringe

- 1** Syringe Water Adjustment
(The water amount can be adjusted by turning the Water Adjuster.)
- 2** Syringe ON/OFF

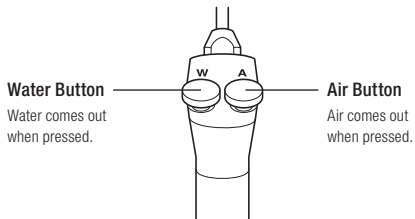

Pressing the both buttons at the same time provides spray water.

17. When the Water Bottle is empty or the Vacuum Bottle is filled with liquid during use

- 1** Turn off the Power Switch (○side).
- 2** Dispose of the sucked liquid (saliva, blood, etc.) in the Vacuum Bottle.
- 3** Remove the Water Bottle and fill it with water.

18. Storage Procedure

- 1 After closing the Vacuum Valve Lever, remove the Handpiece, the Syringe Nozzle, and the Suction Tube and place them in the holder.

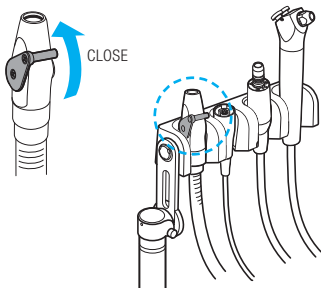

- 2 Store the Vacuum Bottle after disposing of the sucked liquid (saliva, blood, etc.). When storing without disposing of the sucked liquid, put caps on the Vacuum Bottle and the Vacuum Hose.

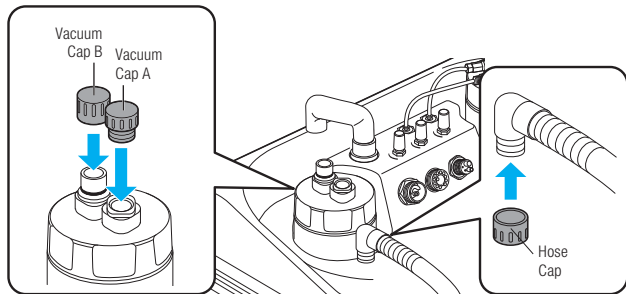

- 3** After dropping the root part of the cords and hoses into the storage part of the Control Unit, wind the rest of the cords and hoses clockwise.

Point 1

Drop the bundled cords and hoses along the right wall.

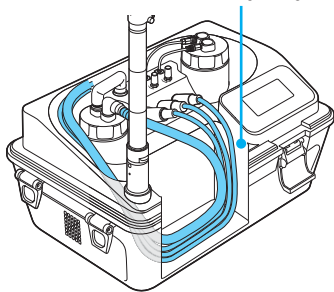

Point 2

Wind the rest of the cords and hoses clockwise.

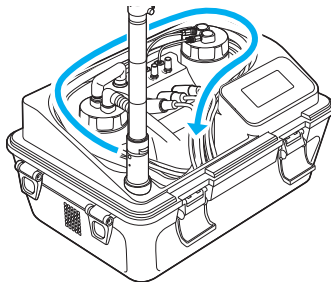

Storage of cords and hoses is introduced in a video. Check the URL or the QR code below.

URL

<http://www.nsk-dental.com/support/videos/>



18. Storage Procedure (continued)

- 4** Release the Holder Arm Lock, support the holder to prevent the cords and hoses from dropping, and then turn the holder slowly until it reaches its lowest to lock.

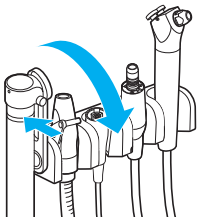

- 5** Pull down the holder bar slowly while supporting the holder to prevent the cords and hoses from dropping.

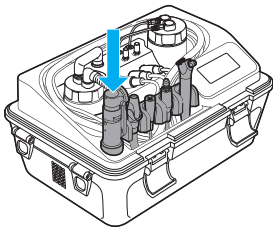

- 6** Set the Top Case on the Control Unit and lock the Buckles (4 places).

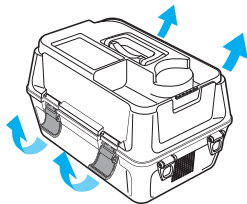

- 7** Store the Foot Control and the Power Cords as in the illustration below.

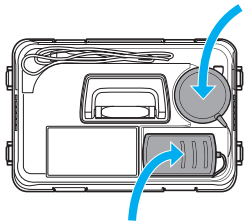

- 8** Put the Top Cover Case on.

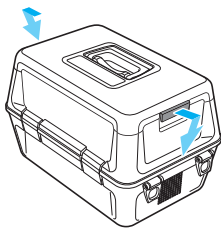

- 9** Set the Shoulder Belt securely to the Belt Hook. Then, carry the device hung the Shoulder Belt on the shoulder.

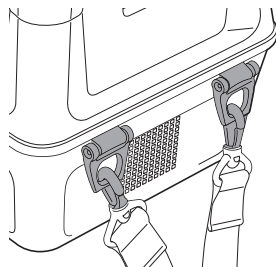

19. Troubleshooting

19-1. Problem and Solutions

When a problem is detected, check the following again. If none of these is applicable or if the trouble is not remedied even after an action has been taken, contact your Authorized NSK Dealer.

Problem	Cause	Remedy
No display when turning on the switch.	Insufficient connection of the power cord.	Check the connection.
	Fuse blown.	Replace the fuse.
Water force is not enough when using the Motor/Scaler.	Water is stagnating in the Air Filter.	Drain the Air Filter. (Reference : Operation Manual 10-8 Drainage of Air Filter)
The Vacuum does not suck.	Vacuum Junction Hose is not connected properly.	Securely connect the Vacuum junction hose. (Reference : Operation Manual 5-6 Installing the Vacuum Hose)
	Foreign substance has entered the Vacuum.	Remove the foreign substance.
	Looseness of the Vacuum Bottle Lid.	Securely close the lid.
	The Vacuum Bottle is filled.	Dispose of the sucked liquid.

Problem	Cause	Remedy
Water is not enough.	Water Supply Plug/Air supply Plug is not connected properly.	Check the connection of the Water Plug.
No water/air is supplied from the Syringe.	Water Supply Plug/Air supply Plug is not connected properly.	Check the connection of the Water Plug.
	The syringe hose is bent, or foreign substance entered.	Stretch the bend of the hose, or remove the foreign substance.
Air force from the Syringe is weak, or there is no air from the Syringe	Water is stagnating in the Air Filter.	Drain the Air Filter. (Reference : Operation Manual 10-8 Drainage of Air Filter)
	The Air Filter clogging.	

19-2. Error Code (When the Error Code is displayed)

Immediately stop all operation of the devices when an error code is displayed. Press Motor/Scaler ON/OFF Key or step on the foot control (FC-76S) again or turn on the device again to see if the error is resolved. If the error code is displayed again, refer to the following table and take appropriate actions. If none of these is applicable, a failure of this product is suspected. Contact your Authorized NSK Dealer.

Error Code	Object	Cause of the Error	Remedy
Err 00	Motor	Exceeding the maximum set torque value	Release the motor from the load.
Err 04		Using the motor for an extended period	Cool down the motor.
Err 08		Used in an extended period exceeding the set value	Remove the load from the motor and the handpiece, then release the foot control.
Err 09		Insufficient connection of the motor cord	Check that the motor is correctly connected to the motor cord.
Err 17	Compressor	Compressor abnormality (Open phase, low voltage, excessive load)	Check that the syringe hose is not twisted or stepped on.
			Turn off the Power Switch and turn it on again while pressing the Air Button on the syringe. Then keep pressing the Air Button for 3 minutes. If the error is not eliminated after the procedure above, repeat the procedure a few times. When the error continues to appear, a failure of the device is suspected. Contact your Authorized NSK Dealer.
Err 19	Control Unit	Abnormal temperature in the Control Unit	Use within the temperature range of the use environment.
Err 29	Scaler	Insufficient connection of the handpiece	Check that the handpiece is correctly connected to the scaler cord.
		Program Error	



Operation procedure of this product is introduced in a movie. Check the URL below or the QR code.

<http://www.nsk-dental.com/support/videos/>